

Shock-Safe Fuseholder, 5 x 20 / 6.3 x 32 mm, Slotted Cap/Fingergrip, IEC: 500 VAC, UL/CSA: 600 VAC/DC



Socket with Slotted Cap
 Caps must be ordered separately (see accessories)

Socket with Fingergrip Cap

500 VAC · 4 W/10 A (VDE) · 600 VAC/DC · 20 A (UL/CSA)

See below:
[Approvals and Compliances](#)

Description

- Fuseholder for 500 VAC applications
- Cap is available slotted or with fingergrip
- 5x20: 3.2W / 6.3x32: 4W

Applications

- Equipment with three-phase supply (400 VAC)

Weblinks

[pdf data sheet](#), [html datasheet](#), [General Product Information](#), [Packaging details](#), [Distributor-Stock-Check](#), [Accessories](#), [Detailed request for product](#), [Microsite](#)

Technical Data

Shock-Safe Category	PC2
Fuse-Link	5 x 20 or 6.3 x 32 mm
Mounting	Panel mount, Front Side
Attachment	Fixing Nut
Terminal	Solder or Quick-Connect 6.3 x 0.8 mm
Rated Voltage	500 VAC (VDE), 600 VAC/DC (UL/CSA)
Rated current	10 A (VDE), 20 A (UL/CSA)
Rated Power Acceptance IEC	4 W / 10 A @ Ta 23 °C 3.2 W / 10 A for 5x20 mm fuse-link, see derating curves
Degree of Protection	IP 40
Protection Class	Suitable for appliances with protection class I acc. to IEC 61140
Admissible Ambient Air Temp.	-40 °C to 85 °C
Climatic Category	40/085/21 acc. to IEC 60068-1
Material: Socket	Thermoset, black, UL 94V-0
Material: Terminals	Tin-Plated Copper Alloy
Unit Weight	9 g / 5.36 g
Storage Conditions	0 °C to 60 °C, max. 70% r.h.
Product Marking	 Type, Rated Voltage, Power Rating, Rated current, Certification marks

Soldering Methods	Iron Soldering Profile
Solderability	350 °C / 2 sec acc. to IEC 60068-2-20, Test Ta, method 2
Resistance to Soldering Heat	350 °C / 10 sec acc. to IEC 60068-2-20, Test Tb, method 2
Contact Resistance	≤ 10 mΩ at 100 mA acc. to IEC 60127-6
Dielectric Strength	> 3kV > 4kV between life parts (50Hz: 1 min)
Impulse Withstand Voltage	> 4kV between life parts > 6kV between life parts
Insulation Resistance	> 10 MΩ between life parts > 100 MΩ between life parts (500 VDC: 1 min)
Overvoltage Category	II acc. to IEC 60664-1
Pollution Degree	2 acc. to IEC 60664-1
Admissible Torque on Fixing Nut	max 1.2 Nm
Panel Thickness	max 9 mm



Approvals and Compliances

Detailed information on product approvals, code requirements, usage instructions and detailed test conditions can be looked up in [Details about Approvals](#)

SCHURTER products are designed for use in industrial environments. They have approvals from independent testing bodies according to national and international standards. Products with specific characteristics and requirements such as required in the automotive sector according to IATF 16949, medical technology according to ISO 13485 or in the aerospace industry can be offered exclusively with customer-specific, individual agreements by SCHURTER.

Approvals

The approval mark is used by the testing authorities to certify compliance with the safety requirements placed on electronic products.
 Approval Reference Type: FEC

Approval Logo	Certificates	Certification Body	Description
	VDE Approvals	VDE	VDE Certificate Number: 137910
	UL Approvals	UL	UL File Number: E39328



Product standards

Product standards that are referenced

Organization	Design	Standard	Description
	Designed according to	IEC 60127-6	Miniature fuses. Part 6. Fuse-holders for miniature fuse-links
	Designed according to	UL 4248-1	Fuseholder general requirements
	Designed according to	CSA C22.2 no. 4248.1	Fuseholder general requirements





Application standards

Application standards where the product can be used

Organization	Design	Standard	Description
	Designed for applications acc.	IEC/UL 60950	IEC 60950-1 includes the basic requirements for the safety of information technology equipment.
	Designed for applications acc.	IEC 60335-1	Safety of electrical appliances for household and similar purposes. Meets the requirements for appliances in unattended use. This includes the enhanced requirements of glow wire tests acc. to IEC 60695-2-11 or -12 & -13.

Compliances

The product complies with following Guide Lines

Identification	Details	Initiator	Description
	CE declaration of conformity	SCHURTER AG	The CE marking declares that the product complies with the applicable requirements laid down in the harmonisation of Community legislation on its affixing in accordance with EU Regulation 765/2008.
	RoHS	SCHURTER AG	Directive RoHS 2011/65/EU, Amendment (EU) 2015/836
	China RoHS	SCHURTER AG	The law SJ / T 11363-2006 (China RoHS) has been in force since 1 March 2007. It is similar to the EU directive RoHS.
	REACH	SCHURTER AG	On 1 June 2007, Regulation (EC) No 1907/2006 on the Registration, Evaluation, Authorization and Restriction of Chemicals 1 (abbreviated as "REACH") entered into force.
	White paper Glow wire test	SCHURTER AG	Meets the requirements of IEC 60335-1 for appliances in unattended use. This includes the enhanced requirements of glow wire tests acc. to IEC 60695-2-11 or -12 &-13.

Dimension [mm]

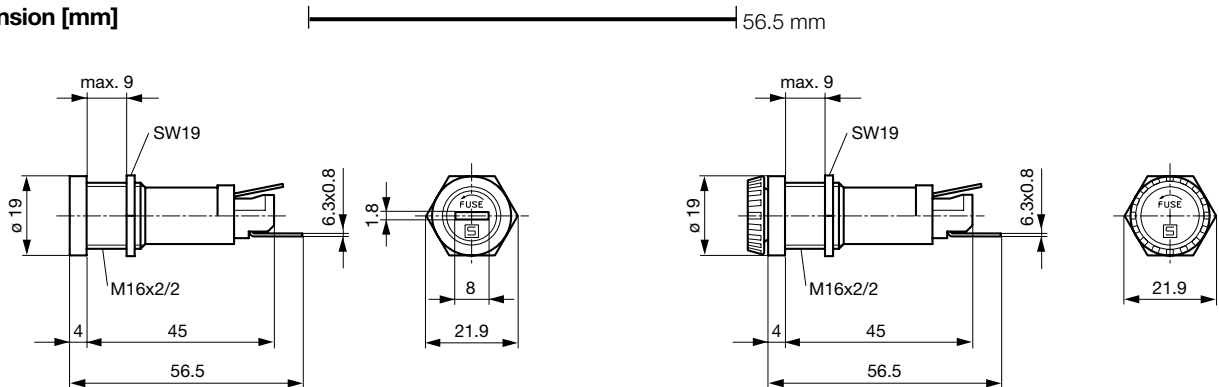

Variant with slotted cap 0031.1631 + 0031.1611/1613

Variant Fingergrip 0031.1631 + 0031.1616

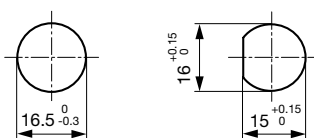

Mounting holes

Derating Curves

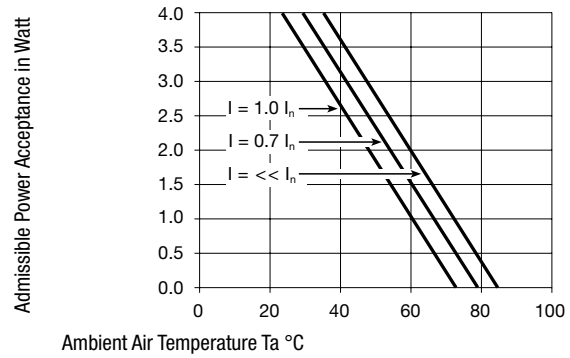
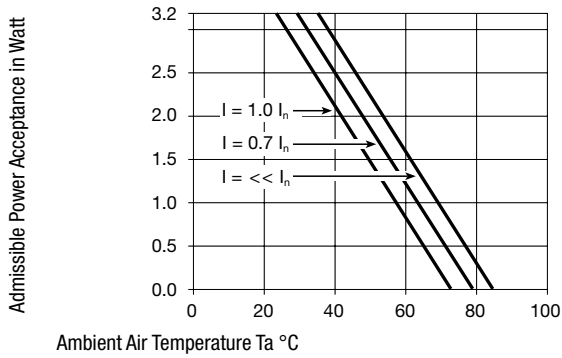

All Variants

Holder	Cap	Fuse-Link	Terminal	Degree of Protection	Remark	Order Number
●	-	5 x 20 or 6.3 x 32mm	Solder	IP40	-	0031.1631
●	-	5 x 20 or 6.3 x 32mm	Quick-Connect 6.3 x 0.8 mm	IP40	-	0031.1623
●	slotted	6.3 x 32mm	Quick-Connect 6.3 x 0.8 mm	IP40	0031.1623 + 0031.1613	0031.1622
●	Fingergrip	6.3 x 32mm	Quick-Connect 6.3 x 0.8 mm	IP40	0031.1623 + 0031.1616	0031.1624
●	slotted	5 x 20mm	Quick-Connect 6.3 x 0.8 mm	IP40	0031.1623 + 0031.1611	0031.1621
●	slotted	5 x 20mm	Solder	IP40	0031.1631 + 0031.1611	0031.1632
●	slotted	6.3 x 32mm	Solder	IP40	0031.1631 + 0031.1613	0031.1633
●	Fingergrip	6.3 x 32mm	Solder	IP40	0031.1631 + 0031.1616	0031.1634

Most Popular.

Availability for all products can be searched real-time: <https://www.schurter.com/en/Stock-Check/Stock-Check-SCHURTER>

Packaging Unit Bulk (50 pcs.)

Required Accessory

Description



Caps to FEC
 Caps to Holder FEC