

Shock-Safe Fuseholder, 5 x 20 mm, Slotted Cap/Fingergrip, Snap stepless, 1.0 - 3.0 mm, IEC 60335-1



Snap-in version  
 from front side  
 horizontal with finger grip  
 fingergrip

250 VAC · 2.5W/10A (VDE) · 500V · 16A (UL/CSA)

See below:  
[Approvals and Compliances](#)

### Description

- Panel Thickness 1.0 - 3.0 mm, Snap stepless
- Compact design
- White color available on request

### Applications

- Household appliances
- Medical Equipment

### References

#### Weblinks

[pdf data sheet](#), [html datasheet](#), [General Product Information](#), [Distributor-Stock-Check](#), [Detailed request for product](#), [Microsite](#)

### Technical Data

Shock-Safe Category	PC2
Fuse-Link	5 x 20mm
Mounting	Panel mount, Front Side
Attachment	Snap-in
Terminal	Solder / Quick-Connect 4.8 x 0.5 mm
Rated Voltage	250VAC, 500V (UL/CSA)
Rated current	10A (VDE), 16A (UL/CSA)
Rated Power Acceptance IEC	2.5W / 10A @ Ta 23 °C
Degree of Protection	IP40
Protection Class	Suitable for appliances with protection class I acc. to IEC 61140
Admissible Ambient Temp.	-40 °C to 85 °C
Climatic Category	40/085/21 acc. to IEC 60068-1
Material: Socket	Thermoplastic, black, UL 94V-0
Material: Terminals	Copper alloy, tin-plated
Unit Weight	5.3 g
Storage Conditions	0 °C to 60 °C, max. 70% r.h.
Product Marking	 Type, Rated Voltage, Power Acc./ Current Rating, Panel Thickness, Certification marks

Soldering Methods	Iron <a href="#">Soldering Profile</a>
Solderability	350 °C / 2 sec acc. to IEC 60068-2-20, Test Ta, method 2
Resistance to Soldering Heat	350 °C / 10 sec acc. to IEC 60068-2-20, Test Tb, method 2
Contact Resistance	≤ 10 mΩ at 100 mA acc. to IEC 60127-6
Dielectric Strength	> 3kV between live parts
Impulse Withstand Voltage	> 4kV between live parts
Insulation Resistance	≥ 10 MΩ between live parts (500VDC: 1 min)
Overvoltage Category	III acc. to IEC 60664-1
Pollution Degree	3 acc. to IEC 60664-1
Resistance to Vibration	acc. to IEC 60068-2-6, test Fc
Panel Thickness	1.0 - 3.0mm

### Approvals and Compliances



Detailed information on product approvals, code requirements, usage instructions and detailed test conditions can be looked up in [Details about Approvals](#)

SCHURTER products are designed for use in industrial environments. They have approvals from independent testing bodies according to national and international standards. Products with specific characteristics and requirements such as required in the automotive sector according to IATF 16949, medical technology according to ISO 13485 or in the aerospace industry can be offered exclusively with customer-specific, individual agreements by SCHURTER.

### Approvals



The approval mark is used by the testing authorities to certify compliance with the safety requirements placed on electronic products.

Approval Reference Type: FPG3

Approval Logo	Certificates	Certification Body	Description
	VDE Approvals	VDE	VDE Certificate Number: 127216
	UL Approvals	UL	UR File Number: E39328
	KTL Approvals	KTL	Korea Testing Laboratory



### Product standards

Product standards that are referenced

Organization	Design	Standard	Description
	Designed according to	IEC 60127-6	Miniature fuses. Part 6. Fuse-holders for miniature fuse-links
	Designed according to	UL 4248-1	Industrial Control Equipment
	Designed according to	CSA C22.2 no. 4248.1	Industrial Control Equipment







### Application standards

Application standards where the product can be used

Organization	Design	Standard	Description
	Suitable for applications acc.	IEC/UL 62368-1	Audio/video, information and communication technology equipment - Part 1: Safety requirements
	Suitable for applications acc.	IEC 60335-1	Safety of electrical appliances for household and similar purposes. Meets the requirements for appliances in unattended use. This includes the enhanced requirements of glow wire tests acc. to IEC 60695-2-11 or -12 & -13.

### Compliances

The product complies with following Guide Lines

Identification	Details	Initiator	Description
	CE declaration of conformity	SCHURTER AG	The CE marking declares that the product complies with the applicable requirements laid down in the harmonisation of Community legislation on its affixing in accordance with EU Regulation 765/2008.
	UKCA declaration of conformity	SCHURTER AG	The UKCA marking declares that the product complies with the applicable requirements laid down in the British Amendment of Regulation (EC) 765/2008.
	RoHS	SCHURTER AG	Directive RoHS 2011/65/EU, Amendment (EU) 2015/863
	China RoHS	SCHURTER AG	The law SJ / T 11363-2006 (China RoHS) has been in force since 1 March 2007. It is similar to the EU directive RoHS.
	REACH	SCHURTER AG	On 1 June 2007, Regulation (EC) No 1907/2006 on the Registration, Evaluation, Authorization and Restriction of Chemicals 1 (abbreviated as "REACH") entered into force.
	White Paper Glow wire test	SCHURTER AG	Meets the requirements of IEC 60335-1 for appliances in unattended use. This includes the enhanced requirements of glow wire tests acc. to IEC 60695-2-11 or -12 & -13.

### Dimension [mm]

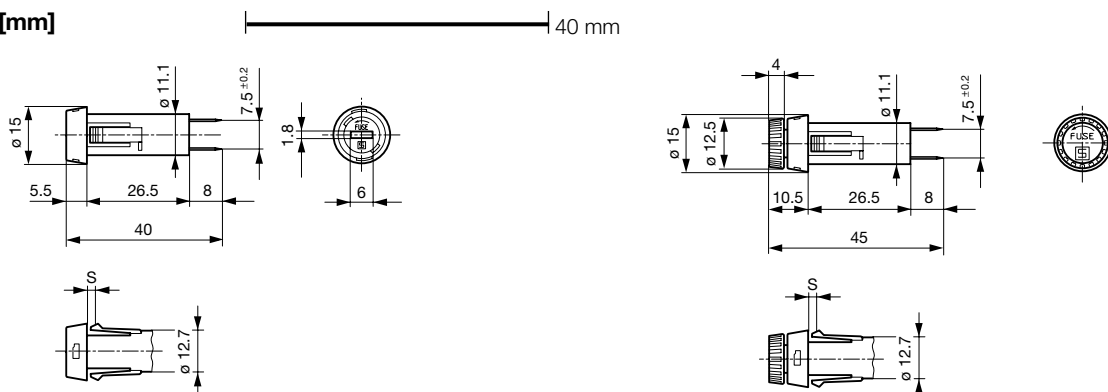

Variants 3101.0030, 3101.0230, 3101.0031 and 3101.0331  
 s = Panel thickness (see variants)

Variants Fingergrasp 3101.0035, 3101.0235, 3101.0036 and 3101.0336  
 s = Panel thickness (see variants)

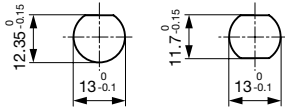

Mounting holes

## Derating Curves

acc. to IEC

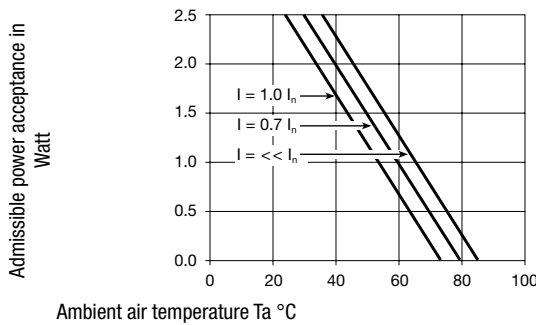

## All Variants

Holder	Cap	Panel Thickness s [mm]	Terminal	Colour Holder	Material	Order Number
●	slotted	1.0 - 1.8mm	Solder	black	Thermoplastic	3101.0030
●	slotted	1.0 - 1.8mm	Quick-Connect 4.8 x 0.5 mm	black	Thermoplastic	3101.0230
●	slotted	2.0 - 3.0mm	Solder	black	Thermoplastic	3101.0031
●	slotted	2.0 - 3.0mm	Quick-Connect 4.8 x 0.5 mm	black	Thermoplastic	3101.0331
●	Fingergrip	1.0 - 1.8mm	Solder	black	Thermoplastic	3101.0035
●	Fingergrip	1.0 - 1.8mm	Quick-Connect 4.8 x 0.5 mm	black	Thermoplastic	3101.0235
●	Fingergrip	2.0 - 3.0mm	Solder	black	Thermoplastic	3101.0036
●	Fingergrip	2.0 - 3.0mm	Quick-Connect 4.8 x 0.5 mm	black	Thermoplastic	3101.0336

Most Popular.

Availability for all products can be searched real-time: <https://www.schurter.com/en/info-center/support-tools/stock-check-distributors>

## Packaging Unit

Bulk 186 x 91 x 91 mm (100 pcs.)